

Rispettando le altezze, la direzione e le angolazioni fissare le basi alla parete a **circa 50 cm** da terra utilizzando le viti in dotazione. Alimentare il trasmettitore e il ricevitore rispettando lo schema come da serigrafia.

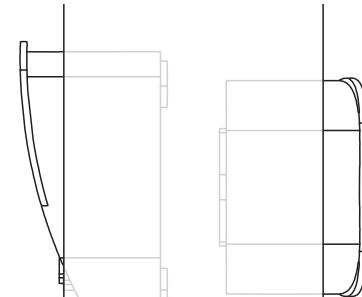

prerollatura per passaggio cavo elettrico

incassabile a muro fino a 30 mm

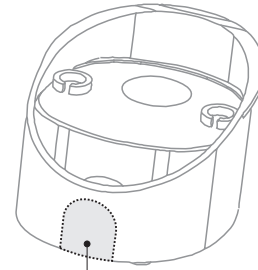
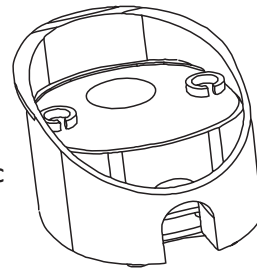
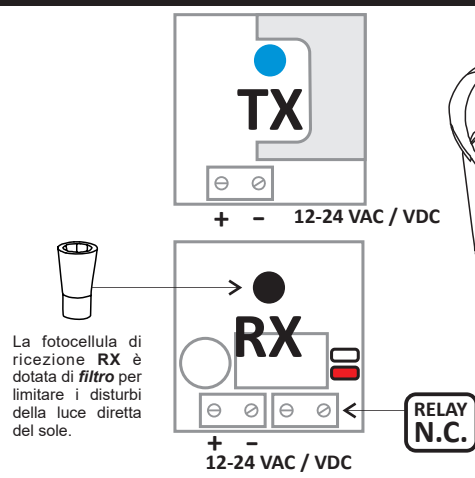
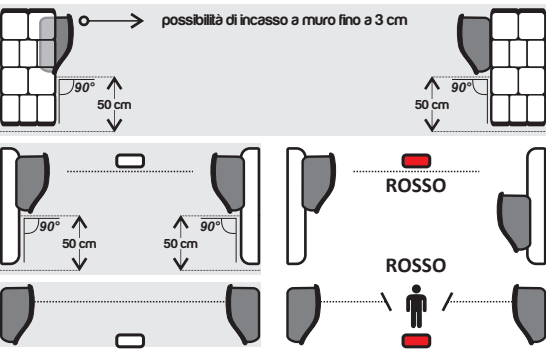
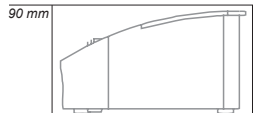
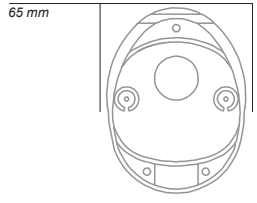
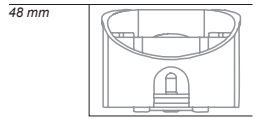

Respecting the height, the direction and the angles fix the bases to the wall at **circa 50 cm** from the ground using the screws supplied. Supply the transmitter and the receiver respecting the diagram in the drawing.

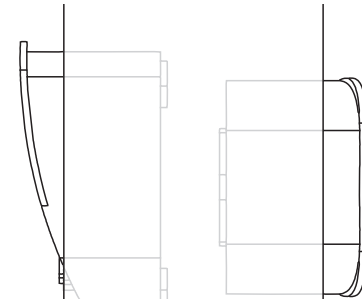
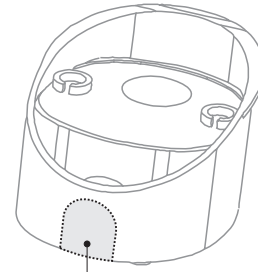
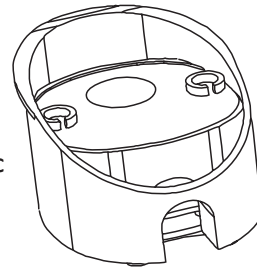
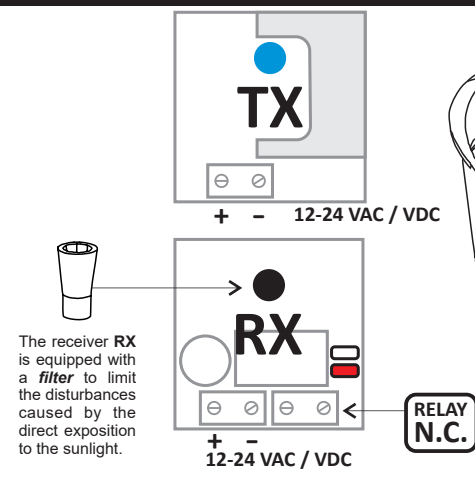
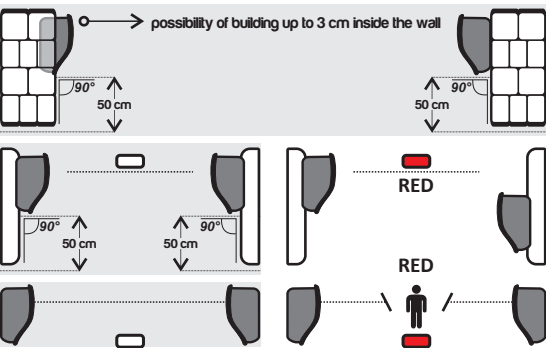

space for electric wire passing from the bottom

recessed mounting option (up to 30 mm)

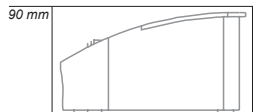
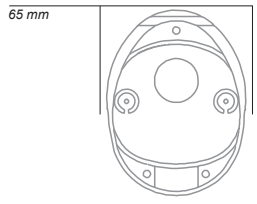
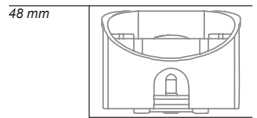

En respectant les hauteurs, la direction et les angles, fixez les bases au mur à une hauteur d'**environ 50 cm** du sol en utilisant les vis fournies. Alimentez le transmetteur et le récepteur comme indiqué dans le schéma sur le dessin.

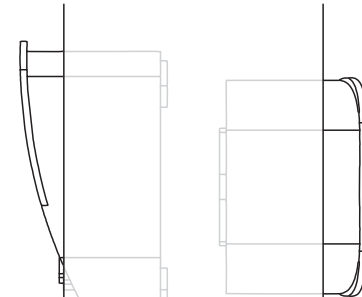
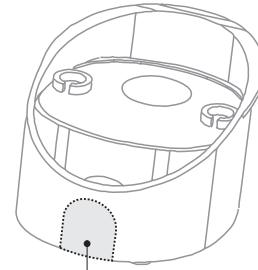
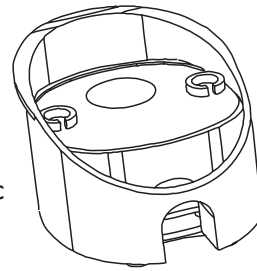
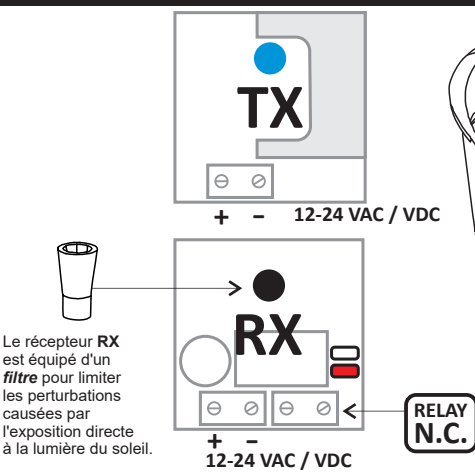
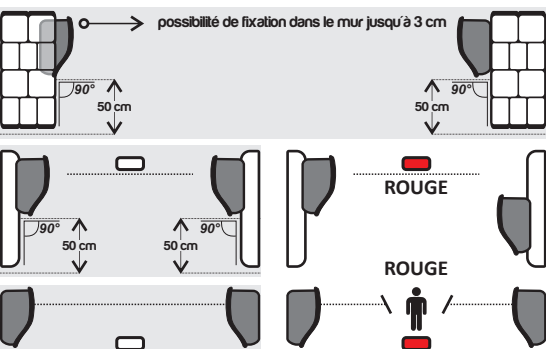

trou de passage pour fil électrique passant du bas

possibilité de fixation dans le mur jusqu'à 30 mm

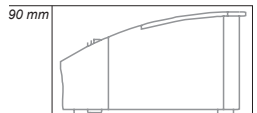
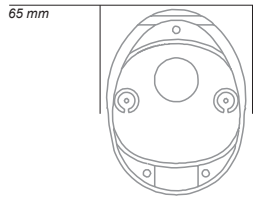
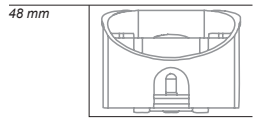

Respeitando a altura, a direção e os ângulos fixar a base à parede com os parafusos fornecidos a cerca de **50 cm do solo**. Alimentar o receptor como mostrado na figura no desenho.

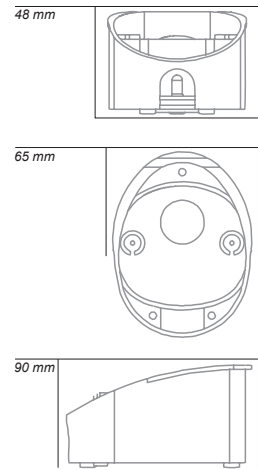
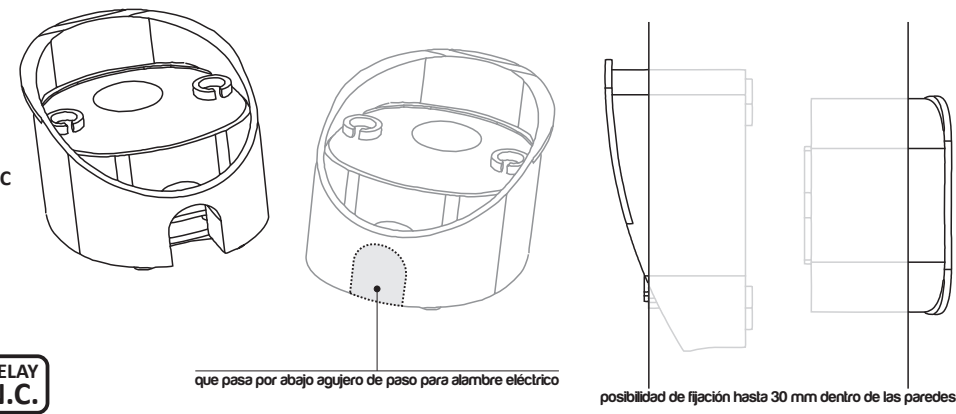
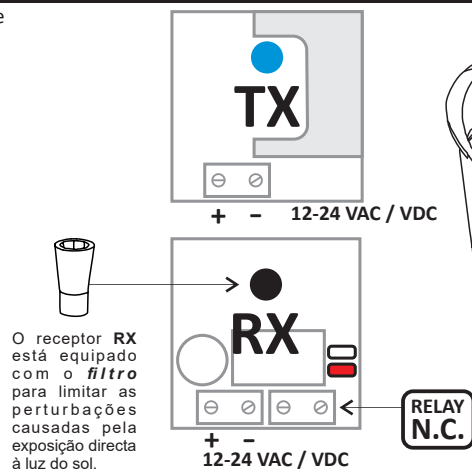
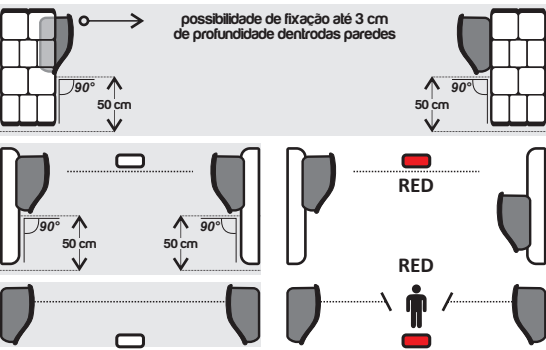

Respetando la altura, la dirección y las angulaciones, fijar las bases a la pared **aproximadamente a 50 cm** del suelo con los dos tornillos en dotación. Alimentar el transmisor y el receptor como en el esquema sobre el diseño.

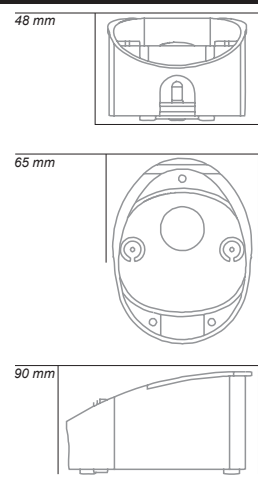
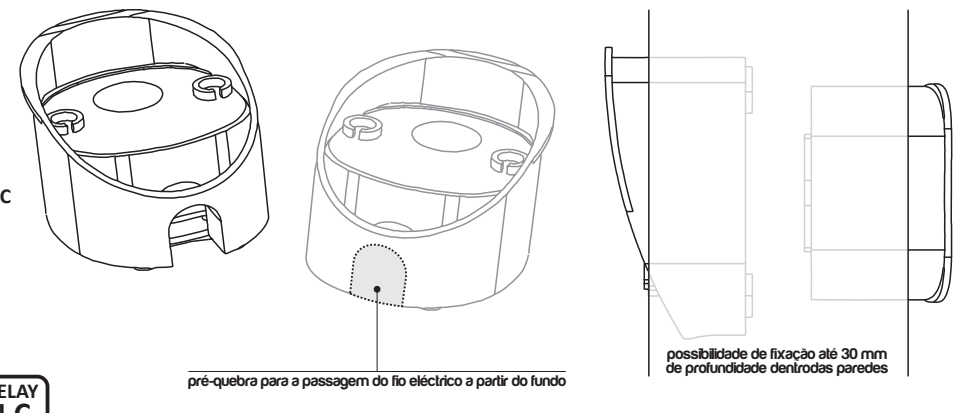
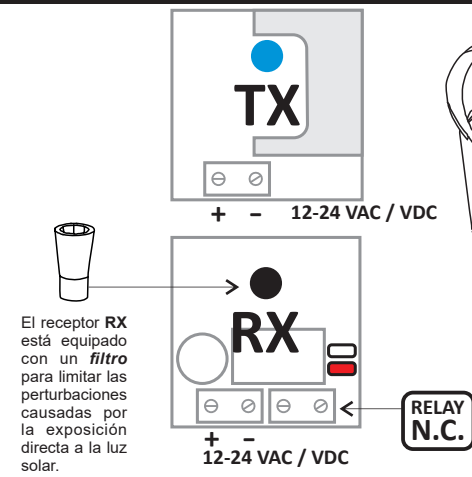
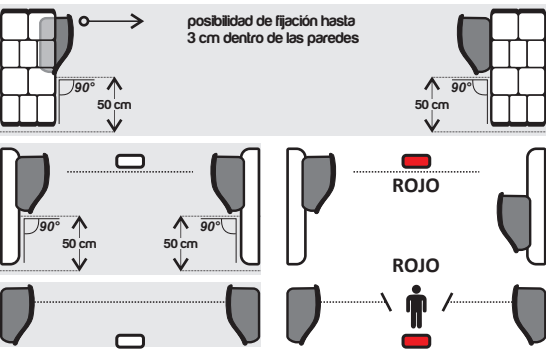

Indem Sie auf die Höhe, die Richtung und die Winkel achten, befestigen Sie die Rückseiten an der Wand in einer Höhe von **zirca 50 cm** mit den mitgelieferten Schrauben. Versorgen Sie den Sender und den Empfänger mit Strom Wie im Schema in die Zeichnung.

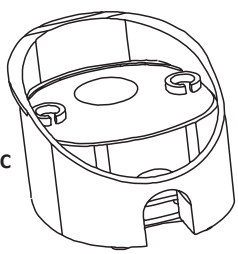
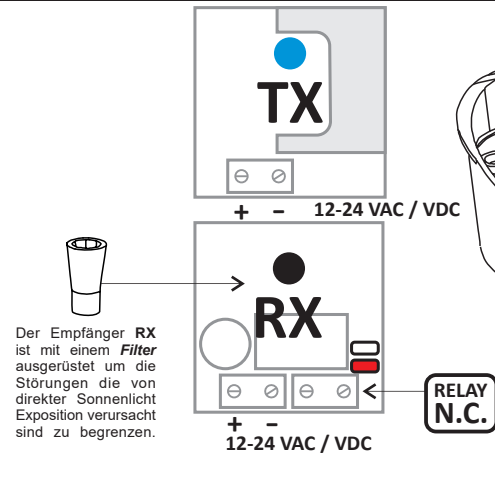
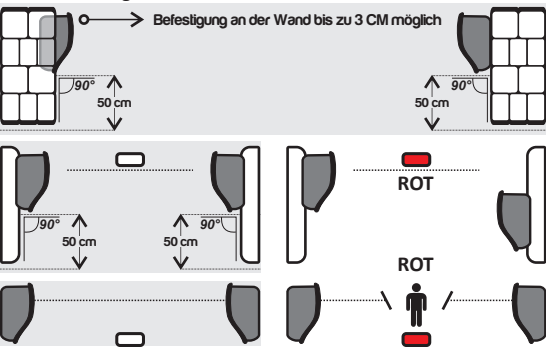

A) Dichiarazione per AEE Domestiche senza Pile o Accumulatori portatili
 INFORMAZIONE AGLI UTENTI DI APPARECCHIATURE DOMESTICHE O PROFESSIONALI
 Ai sensi dell'art. 26 del Decreto Legislativo 14 marzo 2014, n. 49 "Attuazione della Direttiva 2012/19/UE sui rifiuti di apparecchiature elettriche ed elettroniche (RAEE)"
 Il simbolo del cassonetto barrato riportato sull'apparecchiatura o sulla sua confezione indica che il prodotto alla fine della propria vita utile deve essere raccolto separatamente dagli altri rifiuti per permetterne un adeguato trattamento e riciclo. L'utente dovrà, pertanto, conferire gratuitamente l'apparecchiatura giunta a fine vita agli idonei centri comunali di raccolta differenziata dei rifiuti elettrici ed elettronici, oppure riconsegnarla al rivenditore secondo le seguenti modalità:
 - per apparecchiature di piccolissime dimensioni, ovvero con almeno un lato esterno non superiore a 25 cm, è prevista la consegna gratuita senza obbligo di acquisto presso i negozi con una superficie di vendita delle apparecchiature elettriche ed elettroniche superiore ai 400 mq. Per negozi con dimensioni inferiori, tale modalità è facoltativa.
 - per apparecchiature con dimensioni superiori a 25 cm, è prevista la consegna in tutti i punti di vendita in modalità 1contro1, ovvero la consegna al rivenditore potrà avvenire solo all'atto dell'acquisto di un nuovo prodotto equivalente, in ragione di uno a uno.
 L'adeguata raccolta differenziata per l'avvio successivo dell'apparecchiatura dismessa al riciclaggio, al trattamento e allo smaltimento ambientalmente compatibile contribuisce ad evitare possibili effetti negativi sull'ambiente e sulla salute e favorisce il reimpiego e/o riciclo dei materiali di cui è composta l'apparecchiatura.
 Lo smaltimento abusivo del prodotto da parte dell'utente comporta l'applicazione delle sanzioni di cui alla corrente normativa di legge.

For private households: Information on Disposal for Users of WEEE This symbol on the product(s) and / or accompanying documents means that used electrical and electronic equipment (WEEE) should not be mixed with general household waste. For proper treatment, recovery and recycling, please take this product(s) to designated collection points where it will be accepted free of charge. Alternatively, in some countries, you may be able to return your products to your local retailer upon purchase of an equivalent new product. Disposing of this product correctly will help save valuable resources and prevent any potential negative effects on human health and the environment, which could otherwise arise from inappropriate waste handling. Please contact your local authority for further details of your nearest designated collection point. Penalties may be applicable for incorrect disposal of this waste, in accordance with your national legislation. For professional users in the European Union If you wish to discard electrical and electronic equipment (EEE), please contact your dealer or supplier for further information. For disposal in countries outside of the European Union This symbol is only valid in the European Union (EU). If you wish to discard this product please contact your local authorities or dealer and ask for the correct method of disposal.

