

Repartidores Easy-F / Repartidores Easy-F / Répartiteurs Easy-F Splitters Easy-F / Делители Easy-F / Verteiler Easy-F

Refs. 543503, 543603

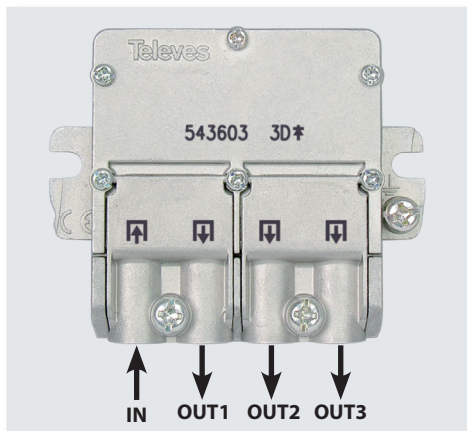

Accesorio / Acessórios / Accessoire / Accessory / Аксессуары / Zubehör
Ref. / Мод. / Art. Nr. 4087

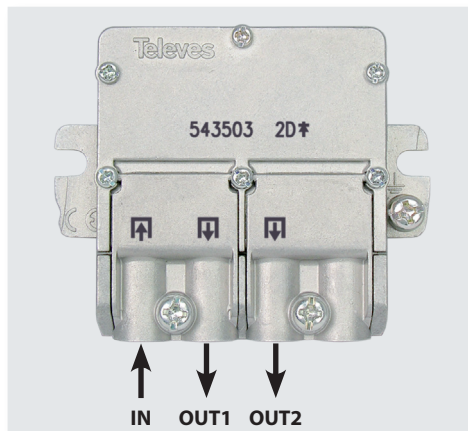

Технические характеристики	Spécificat. techniques	Caractérist. técnicas	Technische Daten	Característ. técnicas	Technical specificat.		543503	543603
Диап. частот	Marge fréquence	Margem frequência	Frequenzbereich	Margen frecuencia	Frequency range		5 - 2400 MHz	
Аттенуация ВХОД - ВЫХОД1/ ВЫХОД2	Atténuation IN - OUT1/ OUT2	Atenuação IN - OUT1/ OUT2	Verteildämpfung IN-OUT1/OUT2	Atenuación IN - OUT1/ OUT2	Attenuation IN - OUT1/ OUT2	5 - 47 MHz	4,4	8,5
						47 - 862 MHz	4,3	8,5
						950 - 2400 MHz	4	7,5
Аттенуация ВХОД - ВЫХОД3	Atténuation IN - OUT3	Atenuação IN - OUT3	Verteildämpfung IN-OUT3	Atenuación IN - OUT3	Attenuation IN - OUT3	5 - 47 MHz	-	5,5
						47 - 862 MHz	-	5
						950 - 2400 MHz	-	4
Режекция между выходами	Réjéct entre sorties	Rejeição entre saídas	Entkopplung Ausgänge	Rechazo entre salidas	Rejection between outputs	5 - 862 MHz	> 15	> 15
						950 - 2400 MHz	> 15	> 15
Макс. напряж.	Voltage max.	Tensão máxima	Max. Spannung	Tensión máxima	Maximum voltage		V	40
Макс. ток	Courant max.	Corrente maxima	Ausgänge-Eingänge DC-Pass	Corriente máxima	Maximum current	OUT → IN		300
Падение DC.	Chute tension	Queda de DC.	Spannungsverlust	Caida D.C.	Drop out voltage	OUT - IN		0,35 (typ) @150 mA
Вес	Poids	Peso	Gewicht	Peso	Weight			56
Размеры	Dimensions	Dimensões	Abmessungen	Dimensiones	Dimensions			57 x 47 x 13

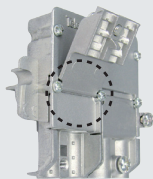

Anclaje de brida para facilitar el conexionado
 Encaixe da braçadeira para facilitar a ligação
 Fixation de la bride pour simplifier la connexion
 Cable clamp joint for easy connection
 Фиксация зажима для удобства соединения
 Easy-F Anschluss um die Montage zu erleichtern

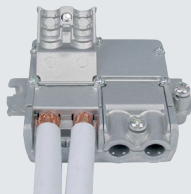
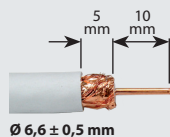

Mismo pelado para cables de una misma brida.
 Mesmo descarnado para cabos da mesma braçadeira
 Même découpe du câble par bride
 Same stripping for cables with the same clamp
 Одинаковая зачистка кабелей одного зажима
 Kabel abisolieren und einstecken

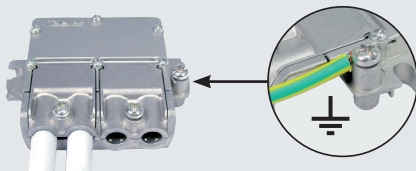
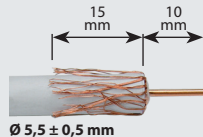

Aplicación

Aplicação

Application

Application

Применение

Anwendung

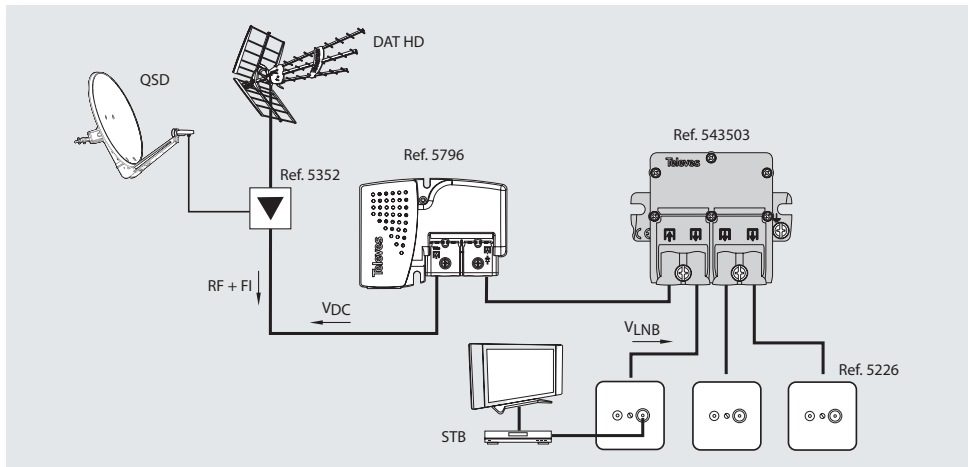

Televis S.A. declara bajo su exclusiva responsabilidad la conformidad de éste producto con las Directivas 2004/108/CEE y 2006/95/CEE.

Puede obtener la Declaración de Conformidad e información complementaria en la página Web:

Televis S.A. indica por este meio, sob sua própria responsabilidade, que este produto está na conformidade com as ordens das directrizes orientadoras 2004/108/CEE e 2006/95/CEE.

Você pode obter a Declaração de Conformidade e informação complementar na Web page:

Televis S.A. énonce par ceci, sous sa propre responsabilité, que ce produit est conforme aux ordres des directives 2004/108/CEE et 2006/95/CEE.

Vous pouvez obtenir la Déclaration de Conformité et l'information complémentaire dans la page Web:

Televis S.A. hereby states, under its own responsibility, that this product is in compliance with the orders of the Directives 2004/108/EEC and 2006/95/EEC.

You can obtain the Declaration of Conformity and complementary information in the Web page:

Televis S.A. (Телевис) с полной ответственностью заявляет о соответствии продукта нормам директив EMC 2004/108/ЕС и 2006/95/ЕС.

Декларацию Соответствия и дополнительную информацию по ней можно получить на страницах web:

Televis S.A. erklärt hiermit für dieses Produkt die Übereinstimmung mit folgenden Richtlinien und Normen: 2004/108/CEE und 2006/95/CEE. Die Konformitätserklärung können Sie auf der Webseite von Televis finden:

www.televis.com

